



恆顥科技股份有限公司  
*Henghao Technology Co.,Ltd.*

# Specification for

## Projective Capacitance Module

Henghao No. HD-T156WP05-F4SB  
Version : 5

Customer Approval		HengHao Technology Co. Ltd.		
		Approval	Checked	PM
Signature		Sky	Matt	Parker
Date		2017/03/24	2017/03/24	2017/03/24

- Approval for SPEC
- Approval for Sample



## History of version

Ver.	Date	Description	Page	Note
A01	2015/11/18	initial	-	SPEC.
A02	2016/1/8	Modify the CG ink foggy to glossy	3	SPEC
B01	2016/1/19	Modify the FPC by customer	6,7	SPEC
B02	2016/2/18	1.Modify the TP thickness 1.5mm → 1.45mm 2.Modify the back protective film size	6.7	SPEC
B03	2016/4/13	SPEC to Sample		Sample SPEC
B04	2016/7/15	STD		Sample SPEC
B05	2017/3/24	Modify the Dent inspector view angle		Sample SPEC



<b><u>Contents</u></b>	<b>Page</b>
<b>1. Product scope</b> .....	<b>3</b>
<b>2. General Characteristics</b> .....	<b>3</b>
2.1 General .....	3
2.2 Product (CG+film sensor ) Structure.....	3
<b>3. Electrical Characteristics(Touch)</b> .....	<b>4</b>
3.1 Absolute Maximum Rating.....	4
3.2 Interface Definition .....	4
<b>4. Physical Characteristics</b> .....	<b>5</b>
4.4 Mechanical drawing.....	6
<b>5. Reliability Test</b> .....	<b>8</b>
<b>6. Appearance inspection</b> .....	<b>9</b>
6.1 purpose .....	9
6.2 Scope of reject criteria.....	9
6.3 Inspection Rule.....	9
<b>7. Packing flow</b> .....	<b>11</b>
7.1 Package drop test .....	11
7.2 Packing procedure .....	12
7.3 Packaging .....	14
7.4 Delivery .....	14
<b>8. Precautions in use of touch panel</b> .....	<b>14</b>
8.1 Purpose.....	14
8.2 Cautions for storage .....	14
8.3 Cautions for unpacking.....	14
8.4 Cautions for handling.....	14
<b>9. Product Substance Management</b> .....	<b>14</b>
<b>10. Others</b> .....	<b>14</b>



## 1. Product scope

This specification is applied to sensor product made by Henghao Technology Co.,Ltd.

## 2. General Characteristics

### 2.1 General

	ITEM	Description	Note
1	Size (active area)	15.6"	-
2	Multi-Touch	10 Fingers	-
3	Interface	USB / RS232	-
4	Approx. Weight	319	g(With PCBa)
5	Firmware	01	

### 2.2 Product (CG+film sensor ) Structure.

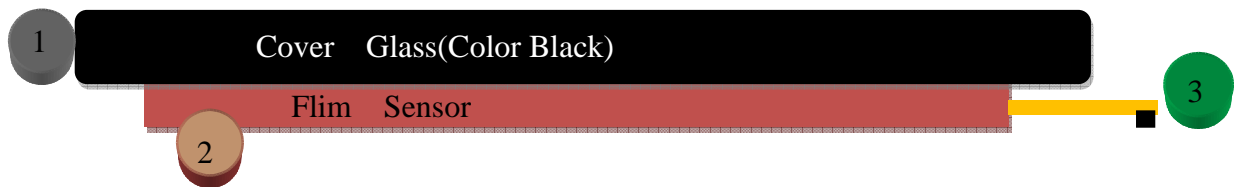

### Key component material list

No.	Item	Specification	Remark
1	Cover Glass	CG Sodaime 1.1mm (Glossy)	
2	Flim Sensor	400um	
3	FPCa	2 layer	

### 3. Electrical Characteristics(Touch)

#### 3.1 Absolute Maximum Rating

ITEM	SYMBOL	MIN	TYP	MAX	UNIT	Remark
Operating Temperature	T <sub>A</sub>	-0	-	60	°C	
Storage Temperature	T <sub>STR</sub>	-20	-	70	°C	
Static Electricity	Make sure the TP grounded while handing					

Note : The product may be damaged permanently while operating with the restricted conditions.

#### 3.2 Interface Definition

##### 3.2.1 PCB Connect USB Interface:

NO.	PIN	Define	Description	Note
1	GND_E		Ground	
2	VDD		Power voltage +5v	
3	GND		Ground	
4	D+		USB single	
5	D-		USB single	

##### 3.2.1 PCB Connect RS232 Interface:

NO.	PIN	Define	Description	Note
1	GND_E		Ground	
2	VDD		Power voltage +5v	
3	GND		Ground	
4	TX		RS232 single	
5	RX		RS232 single	

##### 3.2.2 PCB Output Interface

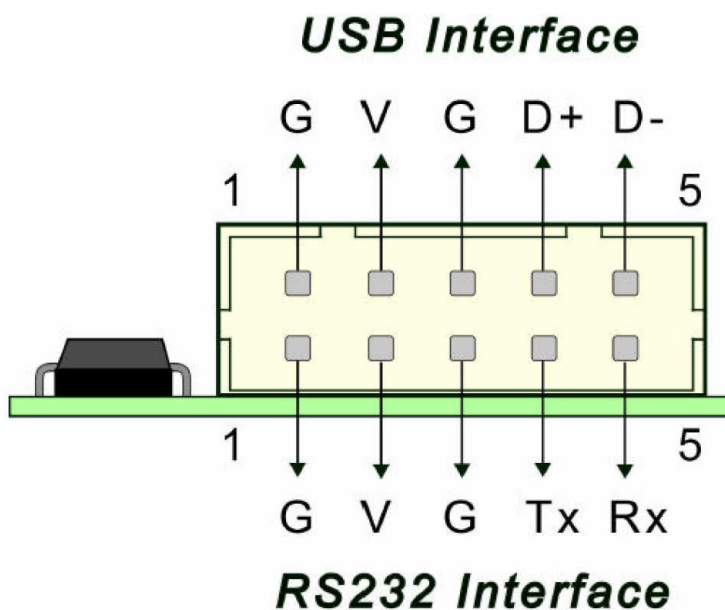



### 3.3 Electrical Characteristic

Parameter	Symbol	Values			Unit	Notes	
		Min	Typ	Max			
Power Supply Input Voltage	VDD	4.5	5	5.5	V		
Power Supply Input Current	Active	I <sub>DD</sub>	-	-	100	mA	
	Idle	I <sub>DD</sub>	-	-	50	mA	
Report rate	(points/sec)	>100Hz			Hz	1	

Note 1: Report rate will vary by channel number ,cover thickness and other parpmeters.

## 4. Physical Characteristics

### 4.1 Optical Characteristics

NO.	Item	Specification	Note
1	Panel Transmittance	Min $\geq$ 85%	
2	Haze	Max $\leq$ 2.5%	

### 4.2 Mechanical Characteristics

NO.	Item	Specification	Note
1	Outline Dimension	V: 387mm H: 235mm	
2	View Area	V: 345.23mm H: 194.54mm	
3	Total Thickness	1.45mm	
4	Surface Hardness	>7H	
5	Air Gap	1.0mm	



4.4 Mechanical drawing

Ver.	REVISION RECORD	DATE
1	New Release	2016.01.15
2	Modify Sensor OCA 厚度與背層PF設計 Δ~Δ	2016.02.18

NOTE:1.Tolerance not specified: .X= ±0.3 .XX=±0.3 .X=±2° .XX=±1°  
 2."( )"Means Reference Dimensions.  
 3."☒"Means important dimension. The Cpk must > 1.33.  
 4.Parallelism. |X1-X1'| ≤ ±0.5mm  
 5.Connector 1 Spec:Aces 50501-044XX-XXX  
 Connector 2 Spec:Aces 50501-056XX-XXX

SCALE	THIRD ANGLE PROJECT	DN
1 : 1		unit:mm

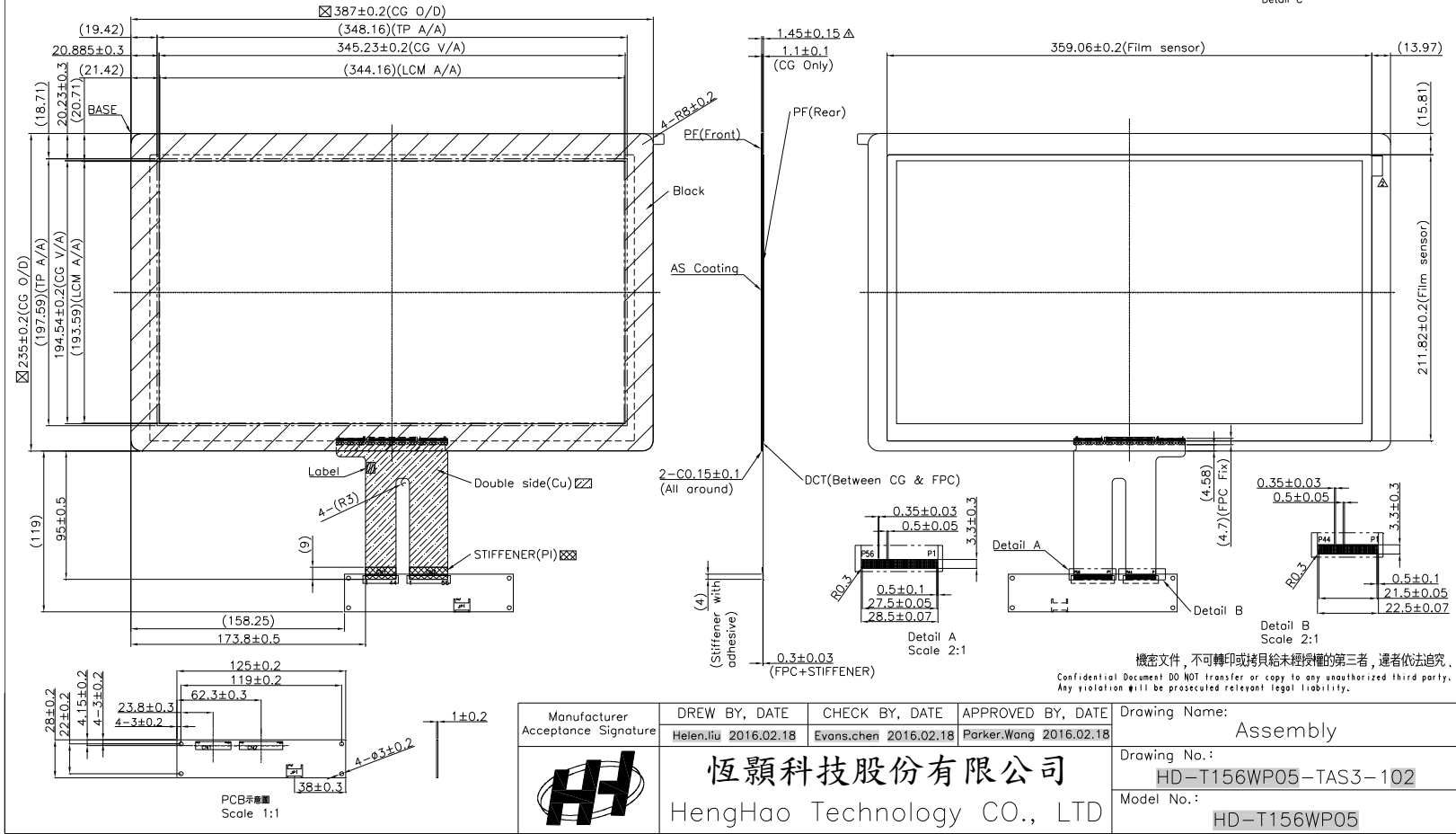
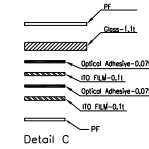

機密文件，不可轉印或拷貝給未經授權的第三者，違者依法追究。  
 Confidential Document DO NOT transfer or copy to any unauthorized third party.  
 Any violation will be prosecuted relevant legal liability.

Manufacturer Acceptance Signature 	DREW BY, DATE	CHECK BY, DATE	APPROVED BY, DATE	Drawing Name:
	Helen.liu 2016.02.18	Evans.chen 2016.02.18	Parker.Wang 2016.02.18	Assembly
HengHao Technology CO., LTD 恆顥科技股份有限公司				Drawing No.:
				HD-T156WP05-TAS3-102
				Model No.:
				HD-T156WP05



Ver.	REVISION RECORD	DATE
1	New Release	2016.01.15
2	Modify Sensor OCA 厚度與背面PF設計	2016.02.18

NOTE:1.Tolerance not specified: .X= ±0.3 .XX=±0.3 .X=±2° .XX=±1°  
 2."( )"Means Reference Dimensions.  
 3."⊠"Means important dimension. The Cpk must > 1.33.  
 4.Parallelism. |X1-X1'| ≤ ±0.5mm  
 5.Connector 1 Spec:Aces 50501-044XX-XXX  
 Connector 2 Spec:Aces 50501-056XX-XXX

SCALE		DN
1 : 1	THIRD ANGLE PROJECT	unit:mm

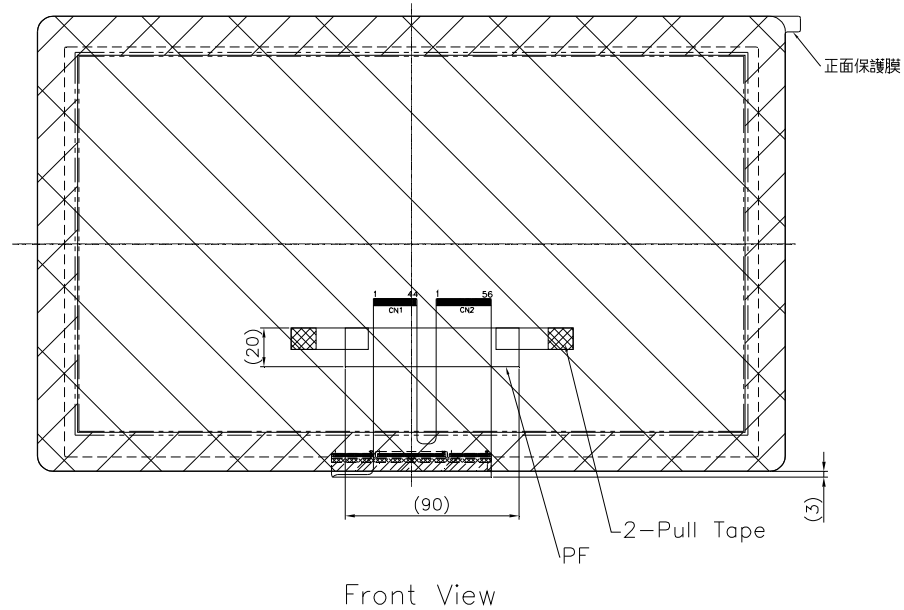

註:PCBa出貨為獨立包裝方式

出貨示意圖

機密文件，不可轉印或拷貝給未經授權的第三者，違者依法追究。  
 Confidential Document DO NOT transfer or copy to any unauthorized third party.  
 Any violation will be prosecuted relevant legal liability.

Manufacturer Acceptance Signature 	DREW BY, DATE	CHECK BY, DATE	APPROVED BY, DATE	Drawing Name:
	Helen.liu 2016.02.18	Evans.chen 2016.02.18	Parker.Wang 2016.02.18	Assembly
恆顯科技股份有限公司 HengHao Technology CO., LTD				Drawing No.:
				HD-T156WP05-TAS3-202
				Model No.:
				HD-T156WP05





## 5. Reliability Test

No	Item	Specification	Q'ty	Note
1	High Temperature-Storage	$70^{\circ}\text{C} \pm 3^{\circ}\text{C}$ 240hr 1. Change the temperature and humidity to the set value ( $+70 \pm 3^{\circ}\text{C}$ ) during a 1-hour ramp. 2. Hold the temperature for 240 hours. 3. Decrease the temperature to $+21^{\circ}\text{C}$ during a 1-hour ramp. 4. After minimum 3 h at ambient conditions, power on to check functionality.	5pcs	
2	Low Temperature-Storage	$-20^{\circ}\text{C} \pm 3^{\circ}\text{C}$ / 240hr 1. Change the temperature and humidity to the set value ( $-10 \pm 3^{\circ}\text{C}$ ) during a 1-hour ramp. 2. Hold the temperature for 16 hours. 3. Decrease the temperature to $+21^{\circ}\text{C}$ during a 1-hour ramp. 4. After minimum 3 h at ambient conditions, power on to check functionality.	5pcs	
3	Thermal shock	$-20^{\circ}\text{C} \pm 3^{\circ}\text{C}$ / $70^{\circ}\text{C} \pm 3^{\circ}\text{C}$ , 70 min / cycle, once cycle 30 minutes at each temperature extreme including a 0-5 minute transition time, 30 cycles total. 1. powered off state to the temperature profile for 30 cycles. 2:- After minimum 3 h at ambient conditions, power on to check functionality.	5pcs	
4	Temp/ Humidity Non-OP	$50^{\circ}\text{C} \pm 3^{\circ}\text{C}$ Humidity: $90 \pm 5\%$ RH 24hr	5pcs	

## 6. Appearance inspection

### 6.1 purpose

To establish appearance standard and maintain product quality.

### 6.2 Scope of reject criteria

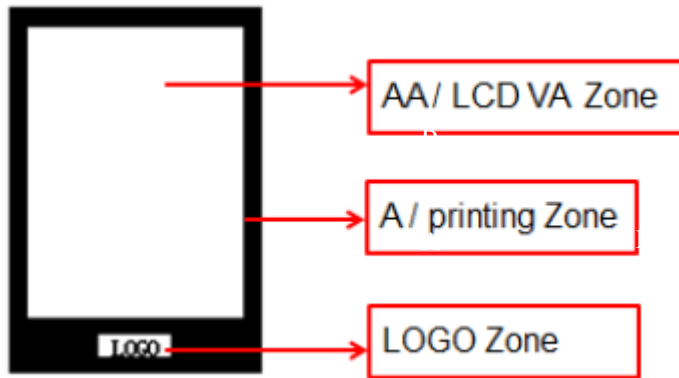

Area	Specification
A	Without any defect point to effect on normal operation.
B	Outside Active Area, None-specify.

### 6.3 Inspection Rule

#### 6.3.1 Inspection condition

- (A) Environmental luminance : 800~1200 Lux, light source distance 50cm~55cm
- (B) Light source : Fluorescent lamp
- (C) Light source color temperature :6500K
- (D) Distance between human eyes and panel : 30cm ~50cm
- (E) Visual angle : 15 degree of all around
- (F) Background : Black
- (G) Inspection Time : 5S~10S

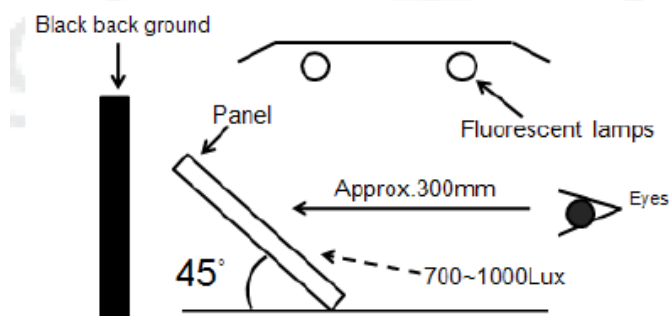

#### 6.3.2 Judge criterion

Judgment under above mentioned criterion (panel must be tested under light transparent), testing goods defect can be visible within 10 seconds, which will be judged as major defects.

#### 6.3.3 FQC Sampling standard:

Sampling criteria: MIL-STD-150E Level II AQL MA:1.0 , MI: 1.5

## 6.4 inspection criteria

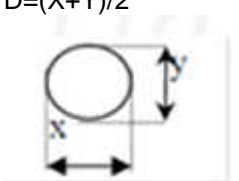
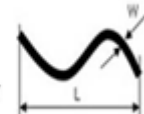
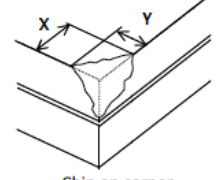
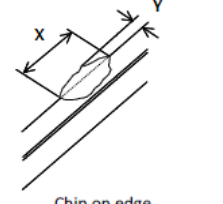
Item	Reject criteria			Defect level
Dot defect (particle/dust/light dot) With Zone AA/ Zone logo / Zone A	$D \leq 0.5\text{mm}$	Ignore	$D=(X+Y)/2$ 	MA
	$0.5\text{mm} < D \leq 1\text{mm}$	$n \leq 6$		
	$1\text{mm} < D$	0		
Bubble / Dent With Zone AA (The vision of inspector should be perpendicular to the surface of the module)	$D \leq 0.5\text{ mm}$	Ignore		MI
	$0.5\text{mm} < D \leq 1\text{mm}$	$n \leq 6$		
	$1\text{mm} < D$	0		
Line defect (Scratch , fibre , foreign matter) With Zone AA/ Zone logo / Zone A	$W \leq 0.1\text{mm}$	Ignore	$W$ : Width $L$ : Length $N$ : Number 	MI
	$L \leq 15\text{mm}$ $0.10\text{mm} < W \leq 0.20\text{mm}$	$n \leq 6$		
	$W > 0.20\text{mm}$	0		
Corner 、 Edge Chipping	$X \leq 2\text{mm}$ and $Y \leq 2\text{mm}$ $T \leq \text{Glass thickness}$	$N \leq 3$	 Chip on corner	MA
	$X \leq 2\text{mm}$ and $Y \leq 1.5\text{mm}$ $T \leq \text{Glass thickness}$ $DS \geq 10\text{mm}$	Each edge $N \leq 3$	 Chip on edge	
Icon \ IR	$D \leq 0.1\text{mm}$	Ignore		MI
Pin hole	$D \leq 0.1$	ignore		

### Notes :

- Identical particle and dirty by visual, will judged as Dot defect.
- $D$  直徑、 $W$  寬度、 $L$  長度、 $DS$  間距、 $N$  數目

## 7. Packing flow

### 7.1 Package drop test

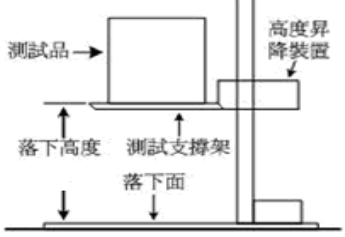
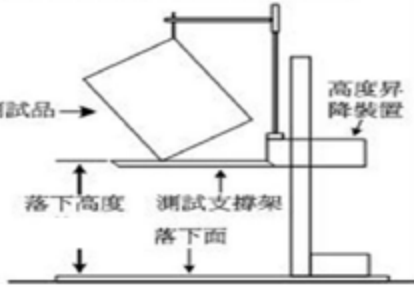
Spec	Remarks
<p>By using the material of PET and EPE, go through the product test by 1 corners/3 edges/6 faces drop test. The test result need to meet the follow criteria :</p>	<p style="text-align: center;">落下測試 正面測試作業方示意图</p>  <p style="text-align: center;">落下測試 側面測試作業方示意图</p> 

## 7.2 Packing procedure

### 一、包裝流程：

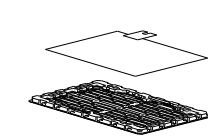

→ 產品以 **glass 面朝下** 放入 Tray



→ Tray 與 Tray 需水平 180 度反轉堆疊。(註 3)

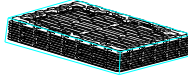

→ 以靜電袋包裝及 OPP 膠帶雙十字方並封口；貼附 L/N 標籤。



→ 將包裝後產品裝入內盒。

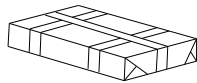

→ 以 EPE 緩衝地蓋，再將 2pcs 內盒放入紙箱封箱。



→ 貼上出貨外箱標籤及廠內 L/N 標籤

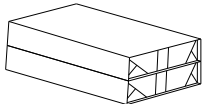

P.S PCB 出貨包裝共用  
供應商來料包裝

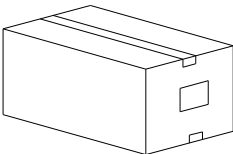
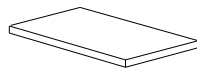

### 二、包裝配置：

成品數量：	1pcs Module / per Tray	1 pcs
成品數量：	16+1 Tray / per S-Bag	16 pcs
成品數量：	2 S-Bag / per Carton	32 pcs
成品數量：	24 Carton / per Pallet	768 pcs

### 三、包裝標籤規格：

1、出貨標籤格式：110mm x 70mm (字型 Arial ,黑色字體)

P/N：依照業務訂單及工單所示編號







D/C：為製造日期 YYMMDD 共 6 碼

L/N：為 HH 工單號碼

VENDER：依照業務訂單及工單所示編碼。

QTY：為實際包裝數量。

SPEC：產品料號(16 碼)

P/N:	 XXXXXXXXXXXX
D/C:	 XXXXXX
L/N:	 XXXXXXXXXX
VENDER:	 XXXXXX
QTY:	 XX
SPEC:	 XXXXXXXX.XXXXXX.XXX

2. L/N.標籤：80mm x 40mm (字型 Arial ,黑色字體)

HengHao	(HH P/N )
批號(L/N)：	(數量)
(條碼)	(總數量)

#### 四、Tray 堆疊方式：

1. 單包設計堆疊高度，如右圖。
2. 產品拿取需從短邊兩側取出或放入，且不可一次多片同時作業。
3. 需確認此防呆斜角及 R 角堆疊是否正確 180 度旋轉，正確堆疊如下。

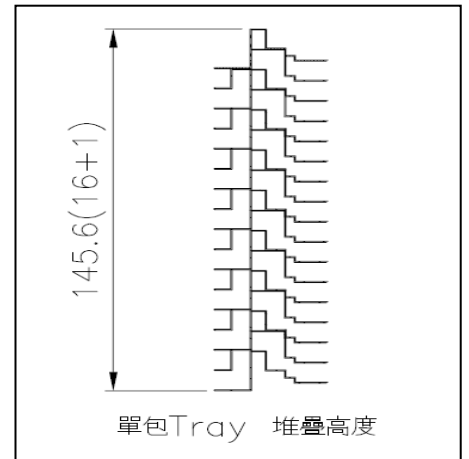

#### 五、注意事項 Note：

1. 產品拿取需從短邊兩側取出或放入，且不可一次多片同時作業。
2. 進出口海(空)運建議使用熏木、塑膠或膠合棧板；內陸運輸或長途陸運建議使用塑膠及木棧板；
3. 棧板堆疊空運運輸含棧板高度不可超過 150cm；內陸運輸或長途陸運含棧板高度不超 180cm
4. 廠內通用棧板建議尺寸表：
  - 一般木頭(煙燻)棧板：1100 mm\*1000 mm \*140mm
  - 塑膠棧板：1100 mm\*900 mm \*140mm (HK 現有品)
  - 瓦楞紙棧板：1150 mm \*920 mm \*120mm (HK 現有品)
  - 1050 mm \*800 mm \* 140mm (KS 現有品)
5. 使用木棧板每層最多可堆疊六箱，其餘打包建議流程參考”WI-MP10-A002 “包裝倉儲作業標準。



## 7.3 Packaging

### 7.3.1 Storage

#### 7.3.1.1. Storage condition

Temperature: 20~30°C/Humidity: 50~60%RH

7.3.1.2. Goods must be kept in original package for long term storage.

7.3.1.3. Don't expose goods under sunshine.

7.3.1.4. Please store the carton according to the UP/DOWN mark for the proper direction.

### 7.3.2 Taking off package

7.3.2.1. When unpack the package, please open the carton according to the UP/DOWN mark for correct procedure.

## 7.4 Delivery

Avoid of high humidity and high temperature. Extremely high or low temperature will have serious influence on the quality.

## 8. Precautions in use of touch panel

### 8.1 Purpose

In order to prevent accidental use and performance deterioration, please keep the following precautions and inhibited points.

### 8.2 Cautions for storage

Store the products at the temperature and humidity mentioned in the specification in a state of package with care not to expose the products to the direct sunlight or stresses. Do not store the touch panel in a high temperature and humidity for a long period of time and avoid storage in the environment where condensation could arise.

### 8.3 Cautions for unpacking

Check the vertical direction before unpacking.

### 8.4 Cautions for handling

8.4.1 Transparency is an important factor for the product. So, please wear clean finger sacks, gloves and mask to protect the products from fingerprint or stain attach, and also hold the portion outside the view area when handling the panel.

8.4.2 Do not put a heavy, hard or sharp object on the product. Film of traces by T-bar area do not pinched .

8.4.3 When attaching a protection sheet on this product at customer side, please confirm its characteristic in advance whether any damage is given to this product. Although some changes may arise in the function of this product by the protection sheet attachment such as operation, cosmetic, etc., however those changes are out of our guarantee.

8.4.4 Even when attaching a protection sheet with adhesion material by our side based on the request from customer, some changes may arise in the function of this product by the protection sheet attachment such as operability, cosmetic, etc., however those changes are out of our guarantee.

## 9. Product Substance Management

9.1 Base on internal document WI-NP04-A001(綠色產品管制物質標準) to control the material restriction.

## 10. Others

10.1 Any issue or dispute on the specification, must be subjected to change after negotiation.

10.2 Revision of the spec. must follow up with written documentation first then is valid.



- 10.3 If Spec. sheet is different to individual spec., please follow up individual spec.
- 10.4 HengHao has no liability for any random spec. modification by buyers without both parties agreement.
- 10.5 HengHao will provide (sensor 3 Months, module 6 month) un-packing product guarantee under operation condition described in this specification.
- 10.6 The clean operation is allowed only Dehydrated alcohol.
- 10.7 HengHao do not guarantee the product specification with re-work samples which do not process in HengHao.